

SENTINEL®

Model 810-4

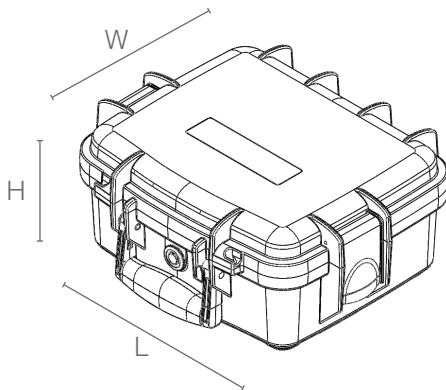

**GUARANTEED
FOR LIFE**



810-4 Specifications

Interior Dimensions	8.2" W x 10.1" L x 4.7" H
Exterior Dimensions	10.5" W x 12.5" L x 5.3" H
Lid Inner Depth	1.2"
Bottom Inner Depth	3.5"
Approx. Weight (empty)	3.1 lbs
Material	Copolymer
Minimum Temperature	-40°F (-40°C)
Maximum Temperature	160°F (71.1°C)

Standard Features

- Injection molded construction
- Watertight, airtight, dustproof
- Automatic pressure relief valve
- Two molded-in padlock brackets
- EPDM gasket
- Ergonomic, cushioned carry handle
- Stainless steel hardware
- Meets airline carry-on regulations
- Two secure, easy-open latches

Certifications (capable of manufacturing to)

- MIL-STD-3010 Test Procedures for Packaging Materials and Containers
- FED-STD-101 Test Procedure for Packaging Material
- ATA Specification 300, Category 1
- ASTM D4169
- IP67 – IEC Standard 60529
- MIL-STD 810
- ASTM D999 – Vibration
- ASTM D6179
- ASTM D5276
- STANAG 4280/AEPP-3 Standard Packaging Test Procedures
- ISTA Test Procedure 1A

Custom Options*

- Foam inserts
- Thermoformed inserts
- Mounting flanges
- Case wall cutouts/routing
- Dividers/trays
- Literature pockets
- Removable lids
- Name plates
- Adhesive labels
- Standard/custom colors
- Shoulder straps

*Contact Gemstar for details and pricing



800-533-3631 | GemstarCases.com

GEMSTAR 
CUSTOM HARD CASES