

STRONGHOLD®

Model SH1436-10

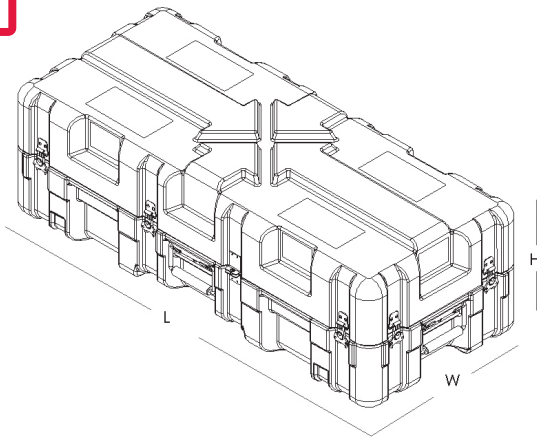

**GUARANTEED
FOR LIFE**



SH1436-10 Specifications

Interior Dimensions	14.1" W x 37.4" L x 10.4" H
Exterior Dimensions	17.3" W x 40.3" L x 12.8" H
Lid Inner Depth	5.0"
Bottom Inner Depth	5.4"
Approx. Weight (empty)	27.0 lbs
Material	Polyethylene
Minimum Temperature	-40°F (-40°C)
Maximum Temperature	160°F (71.1°C)

Standard Features

- Rotationally molded, double-walled construction
- Watertight, airtight, dustproof
- Interlocking stackable design
- Recessed, heavy-duty stainless steel hardware
- Tongue & groove construction with gasket
- Spring-loaded bail handles

Certifications (capable of manufacturing to)

- MIL-STD-3010 Test Procedures for Packaging Materials and Containers
- FED-STD-101 Test Procedure for Packaging Material
- ATA Specification 300, Category 1
- ASTM D4169
- IP67 – IEC Standard 60529
- MIL-STD 810
- ASTM D999 – Vibration
- ASTM D6179
- ASTM D5276
- STANAG 4280/AEPP-3 Standard Packaging Test Procedures
- ISTA Test Procedure 1A

Custom Options*

- Custom foam
- Thermoformed inserts
- Shock mounts
- Literature pockets
- Mounting flanges & brackets
- Automatic pressure relief valve
- Custom colors
- Hinged compartments
- Case wall cutouts
- Name plates
- Mold-in graphics
- Stencil marking
- Removable lid
- Bail handle & wheels

*Contact Gemstar for details and pricing



800-533-3631 | GemstarCases.com

GEMSTAR 
CUSTOM HARD CASES