

# STRONGHOLD®

## Model SH2626-22

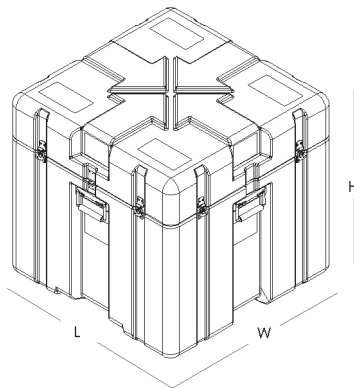

**GUARANTEED  
FOR LIFE**



### SH2626-22 Specifications

Interior Dimensions	26.3" W x 26.3" L x 22.5" H
Exterior Dimensions	29.5" W x 29.5" L x 27.7" H
Lid Inner Depth	2.5"
Bottom Inner Depth	20.0"
Approx. Weight (empty)	45.0 lbs
Material	Polyethylene
Minimum Temperature	-40°F (-40°C)
Maximum Temperature	160°F (71.1°C)

### Standard Features

- Rotatorially molded, double-walled construction
- Watertight, airtight, dustproof
- Interlocking stackable design
- Recessed, heavy-duty stainless steel hardware
- Tongue & groove construction with gasket
- Spring-loaded bail handles

### Certifications (capable of manufacturing to)

- MIL-STD-3010 Test Procedures for Packaging Materials and Containers
- FED-STD-101 Test Procedure for Packaging Material
- ATA Specification 300, Category 1
- ASTM D4169
- IP67 – IEC Standard 60529
- MIL-STD 810
- ASTM D999 – Vibration
- ASTM D6179
- ASTM D5276
- STANAG 4280/AEPP-3 Standard Packaging Test Procedures
- ISTA Test Procedure 1A

### Custom Options\*

- Custom foam
- Thermoformed inserts
- Shock mounts
- Literature pockets
- Mounting flanges & brackets
- Automatic pressure relief valve
- Custom colors
- Hinged compartments
- Case wall cutouts
- Name plates
- Mold-in graphics
- Stencil marking
- Removable lid
- Removable caster wheels

\*Contact Gemstar for details and pricing



800-533-3631 | [GemstarCases.com](http://GemstarCases.com)

**GEMSTAR**   
CUSTOM HARD CASES