

# SENTINEL®

## Model 912-6

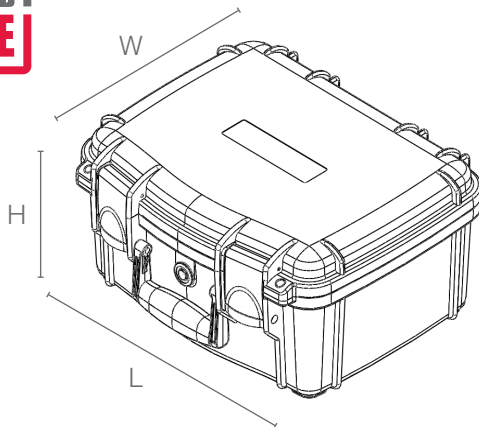

**GUARANTEED  
FOR LIFE**



### 912-6 Specifications

Interior Dimensions	9.4" W x 12.6" L x 6.4" H
Exterior Dimensions	12.0" W x 14.0" L x 6.9" H
Lid Inner Depth	1.3"
Bottom Inner Depth	5.1"
Approx. Weight (empty)	4.3 lbs
Material	Copolymer
Minimum Temperature	-40°F (-40°C)
Maximum Temperature	160°F (71.1°C)

### Standard Features

- Injection molded construction
- Watertight, airtight, dustproof
- Automatic pressure relief valve
- Two molded-in padlock brackets
- EPDM gasket
- Ergonomic, cushioned carry handle
- Stainless steel hardware
- Meets airline carry-on regulations
- Two secure, easy-open latches

### Certifications (capable of manufacturing to)

- MIL-STD-3010 Test Procedures for Packaging Materials and Containers
- FED-STD-101 Test Procedure for Packaging Material
- ATA Specification 300, Category 1
- ASTM D4169
- IP67 – IEC Standard 60529
- MIL-STD 810
- ASTM D999 – Vibration
- ASTM D6179
- ASTM D5276
- STANAG 4280/AEPP-3 Standard Packaging Test Procedures
- ISTA Test Procedure 1A

### Custom Options\*

- Fire retardant resin and inserts
- Foam inserts
- Thermoformed inserts
- Mounting flanges
- Case wall cutouts/routing
- Dividers/trays
- Literature pockets
- Removable lids
- Name plates
- Adhesive labels
- Standard/custom colors
- Shoulder straps

\*Contact Gemstar for details and pricing



800-533-3631 | [GemstarCases.com](http://GemstarCases.com)

**GEMSTAR**   
CUSTOM HARD CASES