

# STRONGHOLD®

## Model SH3543-29

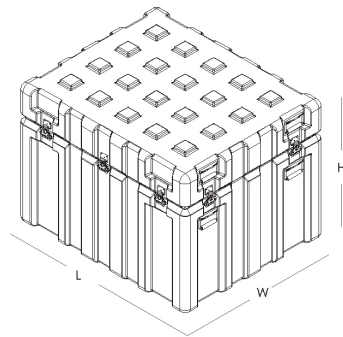

**GUARANTEED  
FOR LIFE**



### SH3543-29 Specifications

Interior Dimensions	35.0" W x 43.0" L x 29.0" H
Exterior Dimensions	39.0" W x 46.9" L x 33.9" H
Lid Inner Depth	4.9"
Bottom Inner Depth	24.1"
Approx. Weight (empty)	96.0 lbs
Material	Polyethylene
Minimum Temperature	-40°F (-40°C)
Maximum Temperature	160°F (71.1°C)

### Standard Features

- Rotationally molded, double-walled construction
- Watertight, airtight, dustproof
- Interlocking stackable design
- Recessed, heavy-duty stainless steel hardware
- Tongue & groove construction with gasket
- Spring-loaded bail handles

### Certifications (capable of manufacturing to)

- MIL-STD-3010 Test Procedures for Packaging Materials and Containers
- FED-STD-101 Test Procedure for Packaging Material
- ATA Specification 300, Category 1
- ASTM D4169
- IP67 – IEC Standard 60529
- MIL-STD 810
- ASTM D999 – Vibration
- ASTM D6179
- ASTM D5276
- STANAG 4280/AEPP-3 Standard Packaging Test Procedures
- ISTA Test Procedure 1A

### Custom Options\*

- Fire retardant resin and inserts
- Custom foam
- Thermoformed inserts
- Shock mounts
- Literature pockets
- Mounting flanges & brackets
- Automatic pressure relief valve
- Custom colors
- Hinged compartments
- Case wall cutouts
- Name plates
- Mold-in graphics
- Stencil marking
- Removable lid
- Reverse application
- Removable caster wheels

\*Contact Gemstar for details and pricing



800-533-3631 | [GemstarCases.com](http://GemstarCases.com)

**GEMSTAR**   
CUSTOM HARD CASES