

STRONGHOLD®

Model SH3434-32

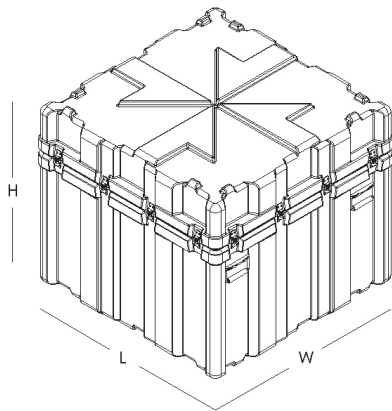

**GUARANTEED
FOR LIFE**



SH3434-32 Specifications

Interior Dimensions	34.9" W x 34.9" L x 32.0" H
Exterior Dimensions	39.0" W x 39.0" L x 34.0" H
Lid Inner Depth	7.8"
Bottom Inner Depth	24.2"
Approx. Weight (empty)	67.0 lbs
Material	Polyethylene
Minimum Temperature	-40°F (-40°C)
Maximum Temperature	160°F (71.1°C)

Standard Features

- Rotationally molded, double-walled construction
- Watertight, airtight, dustproof
- Interlocking stackable design
- Recessed, heavy-duty stainless steel hardware
- Tongue & groove construction with gasket
- Spring-loaded bail handles

Certifications (capable of manufacturing to)

- MIL-STD-3010 Test Procedures for Packaging Materials and Containers
- FED-STD-101 Test Procedure for Packaging Material
- ATA Specification 300, Category 1
- ASTM D4169
- IP67 – IEC Standard 60529
- MIL-STD 810
- ASTM D999 – Vibration
- ASTM D6179
- ASTM D5276
- STANAG 4280/AEPP-3 Standard Packaging Test Procedures
- ISTA Test Procedure 1A

Custom Options*

- Fire retardant resin and inserts
- Custom foam
- Thermoformed inserts
- Shock mounts
- Literature pockets
- Mounting flanges & brackets
- Automatic pressure relief valve
- Custom colors
- Hinged compartments
- Case wall cutouts
- Name plates
- Mold-in graphics
- Stencil marking
- Removable lid
- Reverse Application
- Removable caster wheels
- Bail handle & wheels

*Contact Gemstar for details and pricing



800-533-3631 | GemstarCases.com

GEMSTAR↑
CUSTOM HARD CASES