

### Sentinel Drill Guide Location Diagram

For use with Panel file: 1220-7\_Panel.dxf

Drill into case while aligning Sentinel Drill Guide with ribs and lip of case, as shown

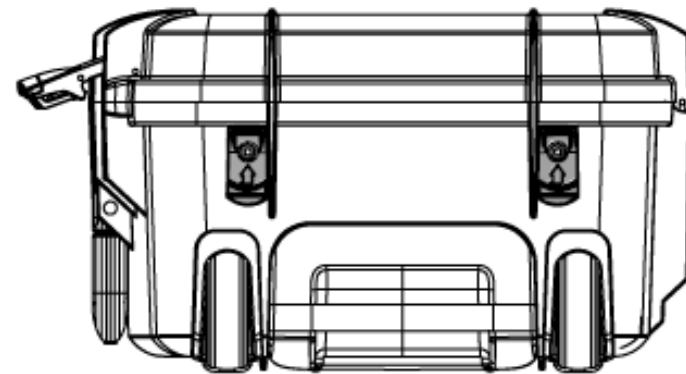
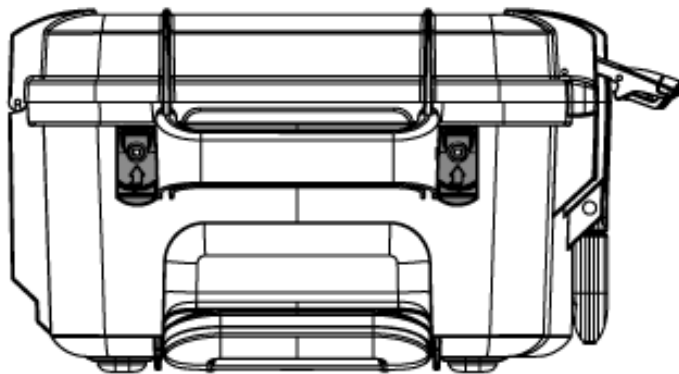
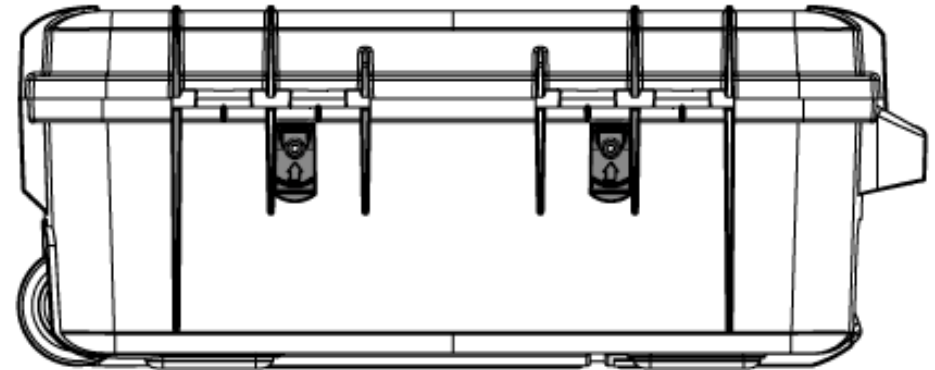
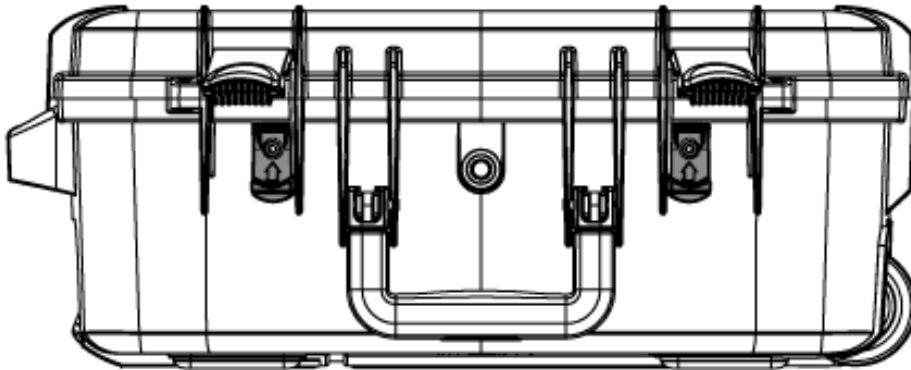

- Please note that this panel hole pattern is not symmetrical
- Please verify panel orientation during design and when placing in case